

coemar

pilota 1200

**instruction
manual**

1st edition, june 2000

Index

1. Packaging	Pag. 3
2. Transportation	Pag. 3
3. Important safety information	Pag. 3
4. Lamp: installation and replacement	Pag. 4
5. Operating voltage and frequency	Pag. 5
6. Installation	Pag. 6
7. Mains connection	Pag. 7
8. Powering up	Pag. 8
9. Operation	Pag. 9
10. Aligning the lamp in the optical system	Pag. 11
11. Maintenance	Pag. 12
12. Spare parts	Pag. 13

Congratulations on having purchased a **coemar** product. You have assured yourself of a fixture of the highest quality, both in componentry and in the technology used. We renew our invitation to you to complete the service information on the previous page, to expedite any request for service information or spares (in case of problems encountered either during, or subsequent to, installation). This information will assist in providing prompt and accurate advice from your **coemar** service centre.

1. Packaging

Following the instructions and procedures outlined in this manual will ensure the maximum efficiency of this product for years to come.

Open the packaging and ensure that no part of the equipment has suffered damage in transit. In case of damage to the equipment, contact your carrier immediately by telephone or fax, following this with formal notification in writing.

packing list

Ensure the packaging contains:

- 1 **Pilota 1200**
- 1 **instruction manual**
- 1 **iris diaphragm**
- 4 **shutter blades**
- 1 **spigot**

2. Transportation

The **Pilota 1200** should be transported in its original packaging or in a **coemar** approved flight case.

3. Important safety information

Fire prevention:

1. **Pilota 1200** utilises a Philips MSR 1200 SA. The use of any other lamps is not recommended and will null and void the fixture's warranty.
2. Never locate the fixture on any flammable surface.
3. The minimum distance from flammable materials: 2 m.
4. The minimum distance from the closest illuminable surface: 10 m..
5. Replace any blown or damaged fuses only with those of identical values. Refer to the schematic diagram if there is any doubt.
6. Connect the projector to main power via a thermal magnetic circuit breaker.

Prevention of electric shock:

1. High voltage is present in the internals of the unit. Isolate the projector from mains supply prior to performing any function which involves touching the internals of the unit, including lamp replacement.
2. For mains connection, adhere strictly to the guidelines outlined in section 7 of this manual.
3. The level of technology inherent in the **Pilota 1200** requires the use of specialised personnel for all service applications; refer all work to your authorised **coemar** service centre.
4. A good earth connection is essential for proper functioning of the projector. Never operate the unit without proper earth connection..
5. The fixture should never be located in an exposed position, or in areas of extreme humidity. A steady supply of circulating air is essential.

Protection against ultraviolet radiation:

1. Never turn on the lamp if any of the lenses, filters, or the housing is damaged; their respective functions will only operate efficiently if they are in perfect working order.
2. Never look directly into the lamps when it is operating.

Safety:

3. The external surface of the unit, at various points, may exceed 150°C. Never handle the unit until at least 8 minutes have elapsed since the lamp was turned off.
4. Always replace the lamps if any physical damage is evident.
5. Never install the fixture in an enclosed area lacking sufficient air flow; the ambient temperature should not exceed 35°C.
6. A hot lamp may explode. always wait for at least 10 minutes to elapse after the unit has been turned off prior to attempting to replace the lamp.
Always wear suitable hand protection when handling the lamp.

4. Lamp: installation and replacement

Pilota 1200 utilizes a Philips MSR 1200 SA lamp rated at 1200W with a GY 22 lamp base. The lamp is available from your authorised **coemar** sales agent:

coemar cod.	105090/1
power	1200 w
luminous flux	96.000 lm
colour temperature	6500° K
lampbase	GY 22
approximate lamp life	500 hours

Attention!

Remove mains power prior to opening up the unit.

The fixture's internal temperature can reach 250° C after 5 minutes, with a maximum peak of 350° C; ensure that the lamp is cold prior to attempting removal. The fixture should be allowed to stand and cool for 10 minutes prior to its removal.

MSR lamps are part of the mercury vapour family of discharge lamps and must be handled with great care. The lamp operates at high pressure, and the slight risk of explosion of the lamp exists if operated over their recommended life.

installing the lamp

- 1) Using a suitable screwdriver remove the two screws (**D**) which affix the lamp assembly unit of the fixture, located towards the rear.



- 2) Remove the lamp assembly.



- 3) Locate the GY 22 lampholder.



4) Insert the lamp. The lamp used is manufactured from quartz glass and should be handled with care; always adhere to the instructions supplied in the packaging. Never touch the glass directly, use the tissue provided in the lamp's packaging. The GY 22 lampbase is asymmetrical in construction so the lamp may be positioned easily. Insert the lamps into the lampholders. **DO NOT USE UNDUE FORCE.** In case of difficulty, simply rotate the lamps and repeat the procedure.



- 5) Reposition the lamp assembly and replace the two screws (**D**) removed previously.



Attention: DO NOT use the projector without first undertaking the realignment of the lamp in the optical train. This ensures that no internal parts are overheated due to incorrect focusing. Refer to section 13 of this manual for instructions regarding lamp alignment.

5. Operating voltage and frequency

Pilota 1200 is fitted with an electronic ballast which stabilises the output voltage to the lamp for any input voltage from 200 to 260V; it therefore requires no modifications to operate within this range of input voltages.

Attention! Should you wish to operate at voltages of 115 V, it is necessary to stipulate this at the time of ordering.

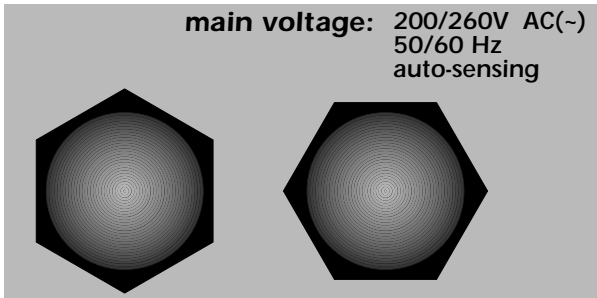

6. Installation

mounting

Please read all the following information prior to using the **pilota 1200**.

lamp

The output of the lamp is a direct function of the position of the arc within the optical system. If the arc is not properly centred within the optics, the beam will appear dull or with a noticeable hot spot. Additionally, the iris diaphragm and dimmer will not work effectively. Refer to section 13 of this manual for instructions on aligning the lamp within the optical train correctly.

risk of fire

Every fixture produces heat, and should therefore be installed in a well-ventilated position. The minimum distance from flammable materials: 0,5 m. The minimum distance from the object being illuminated: 2 m.

protection against liquids

The projector contains electric and electronic components that must not come into contact with water, oil, or any liquid.

installing on a stand

pilota 1200 is supplied with a spigot allowing the followspot to be installed easily on a followspot stand. The horizontal movement (left/right) is governed by the positioning the yoke of the fixture on the spigot and we recommend the use of the **coemar** (cod. 8002) followspot stand, which utilises a neoprene collar to allow smooth panning. Prior to installing the **pilota 1200** on the stand, it is important to ensure that the legs of the stand are completely apart and located on a stable, level surface. Lift the extension tube of the stand to the desired height and lock it off in position. The spigot may be installed into the tube and then the followspot placed and secured into position.

balancing

coemar adjusts the position of the yoke on the body of the followspot into the position which best balances the followspot when mounted on its stand. The centre of balance of the **pilota 1200** may vary when a colour change device is mounted to the front of the unit. To rebalance the unit, make sure first that projector is sitting horizontally in the stand and loosen the the handles located on the sides of the yoke which will allow it to tilt up and down. Gradually loosen the two hex-head screws located on the sides of the yoke which fix the yoke to the followspot body until the followspot is able to slide easily along its tracks. Slide the body into the position which best balances the unit. When this is done, firmly tighten the two hex screws.

manoeuvring the followspot

To operate the followspot in a smooth manner, gradually loosen the two handles indicated in the diagram below; A for vertical tilt movement, B and C for horizontal panning.

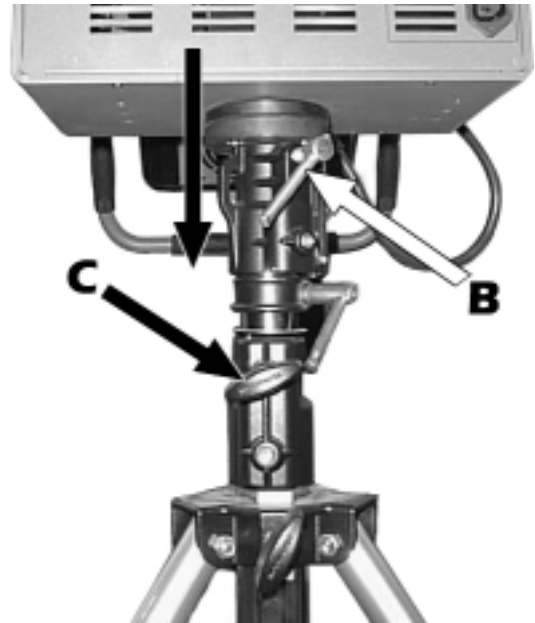

7. Mains connection

cable preparation

The mains cable provided is thermally resistant, complying to the most recent international standards.

NB: In case of cable replacement, similar cable with comparable thermal resistant qualities must be used exclusively (cable 3x1,5 ø external 10 mm, rated 300/500V, tested to 2KV, operating temperature -40° +180°).

mains connection

Pilota 1200 is fitted with an electronic ballast which stabilises the output voltage to the lamp for any input voltage from 180 to 260V; it therefore requires no modifications to operate within this range of input voltages.

Should you wish to operate at voltages of 115 V, it is necessary to stipulate this at the time of ordering.

Prior to connecting the unit to your mains supply, ensure that the model in your possession correctly matches the mains supply available to you.

For connection purposes, ensure your plug is of a suitable rating: 9.5 amps.

Locate the mains cable which exits the unit and connect as shown below:

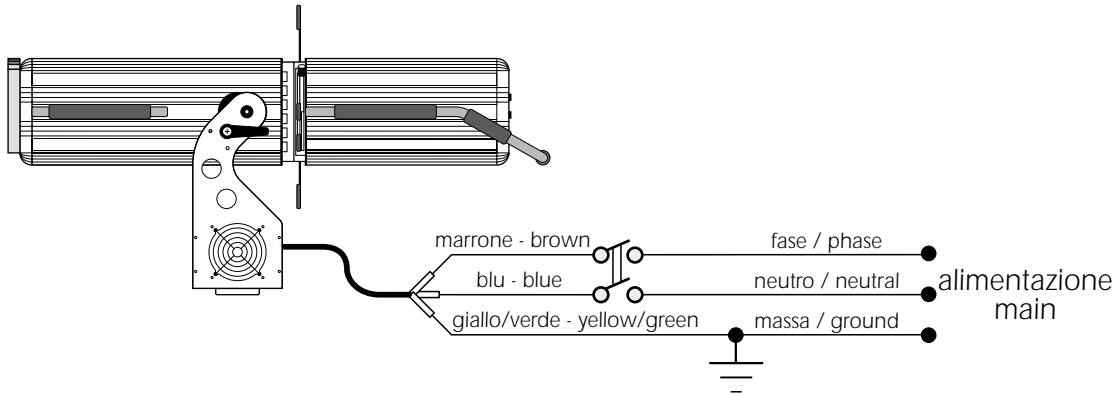

protection

The use of a thermal magnetic circuit breaker is recommended for each **Pilota 1200**.

A good earth connection is essential for the correct operation of the fixture. Strict adherence to regulatory norms is strongly recommended.



ATTENTION!, DANGER!



The electronic ballast with which the **Pilota 1200** is equipped, as with other electronic devices, requires that the neutral cable be of correct size to ensure correct balancing of the load with the active.

Please ensure that proper consideration has been given to this point when connecting the fixture to mains power.

**Pilota 1200 requires a good earth connection to operate properly.
Do not operate the unit unless the green/yellow earth cable is correctly fitted.**

8. Powering up

After having followed the preceding steps, turn on the mains to the followspot, and then turn on the **power** switch. The followspot should be turned on with the **standby** switch in the **off** position.

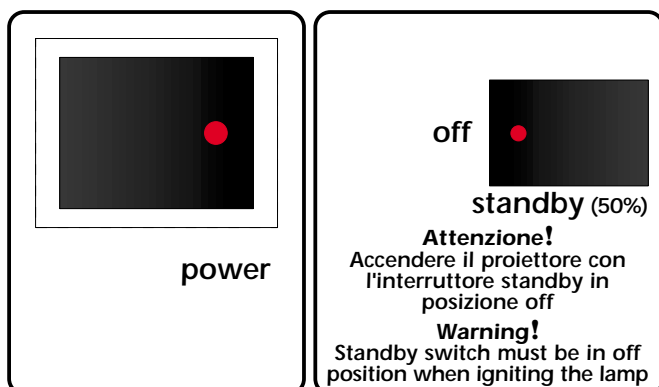

standby switch 50%

The standby 50% switch allows the power output to be reduced to 50% of maximum output.

During periods of time when the followspot is not required in a production, we recommend switching the standby switch to on, thereby reducing the internal temperature of the followspot and prolonging the working life of the internal components.

During a short pause in a show when you may not wish to shut off the lamp entirely, shut down the dimmer, open up the iris diaphragm (if installed) and set the switch to standby. Set the switch to full on just prior to re-using the followspot in your show. The **pilota 1200** will silently power up to maximum output immediately. The cooling fan is powered directly from the ballast, and so will operate from the moment the ballast is powered up. It is advisable to keep the fan on for a short time after the lamp has been switched off in order to cool the unit effectively.

9. Operating

focusing and zoom

pilota 1200 utilises high definition lenses which allow zoom adjustment and focusing. These two functions are operated simply by sliding the two adjusters located on the right of the followspot body longitudinally along the body until the required zoom angle and focus is achieved. Lock off the position of the lenses by turning the knobs in the clockwise direction.

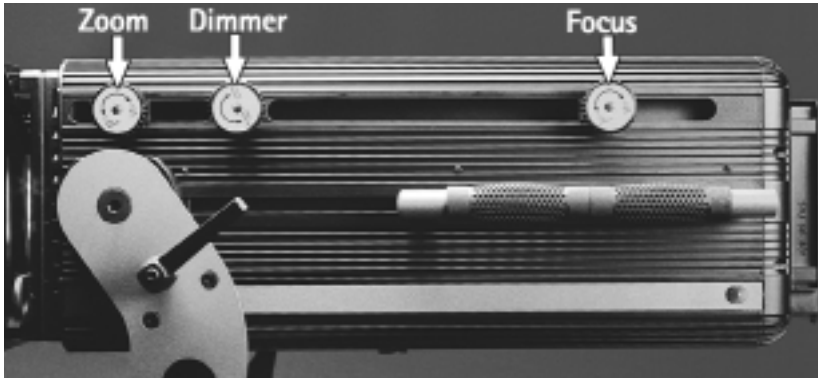

dimmer

Via the dimmer located in the **pilota 1200** it is possible to smoothly dim down the output of the followspot, with no loss in colour temperature, from maximum output to blackout. The function is operated via the knob located on the side of the followspot; turn it in a clockwise direction to open up the dimmer to allow maximum output or turn it in a counter-clockwise direction to gradually dim down the output to full blackout.

iris diaphragm

The iris diaphragm is supplied with the unit but not installed. It is installed by simply sliding it into the guide located between the optics of the unit and the lamp assembly and operated via the handle provided with the unit.



The iris diaphragm reduces the diameter of the beam without affecting the intensity of the output. The long handle allows easy access to operate the unit from either side of the followspot.



framing shutters

4 framing shutters are included in the packaging. These are inserted in the appropriate slots located, as shown in the picture below, between the optics of the unit and the lamp assembly. The use of these shutters allows the output to be in the form of a variety of geometric shapes.



internal colour changer

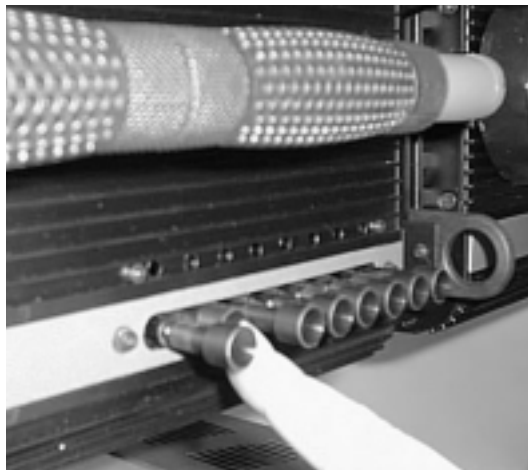

The internal colour changer of the **pilota 1200** contains 6 colours, a release-colour function and a colour correction filter.

The internally-illuminated selection buttons allow the correct button to be easily selected and identified even in poorly-lit environments.

The conversion filter is located on the second button and may be selected in tandem with any other colour. It will not be released by the release-colour function.

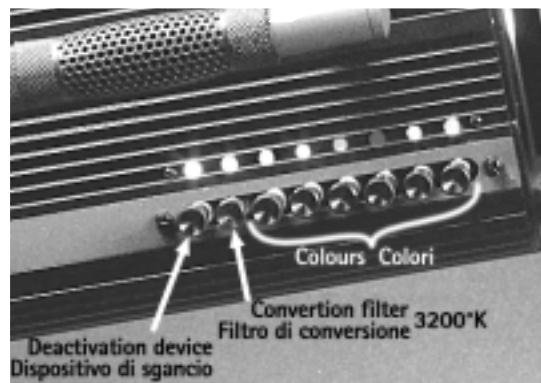

installing accessories

If required, an external colour filter frame or an external colour change unit may be utilised. These accessories are fitted to the front of the **pilota 1200**. When installing either of these accessories, make sure that it is correctly installed and held in place by the retaining spring.

Also available is a followspot stand (benny version cod.8002) specifically designed for the **pilota 1200**.

colour changer and colour filter frame

coemar manufactures both an external colour changer and a colour filter frame which fit to the front of the **pilota 1200**.

If you intend installing the colour changer, you may wish to re-balance the unit.

colour filter frame

The colour filter frame allows the insertion of a sheet of colour filter of dimensions 150mm X 120 mm.

We recommend the use of high quality, high temperature colour filter such as Rosco SuperGel.

rebalancing

The installation of the external colour changer may alter the balance of the followspot. To correct any imbalance, refer to the instructions located in section 6 of this instruction manual.

10. Aligning the lamp in the optical system

Aligning the lamp in the optical system is achieved via the 3 adjusters at the rear of the projector. This procedure should be undertaken to properly align the lamp in the optical system and to avoid the possible overheating of the internal components due to the incorrect focusing of the beam onto components not intended to be exposed to this.

alignment procedure

To adjust the lamp, turn on the followspot and allow the lamp to reach maximum intensity (approximately 2 minutes). Direct the beam onto a flat surface some 8 to 10 metres from the followspot. Slide the focus knob forwards so that the beam is totally out of focus. Close down the iris diaphragm to at least half size. The arc of the lamp will appear as a single line and should be at the centre of the beam. Should this not be the case, adjust the lamp position. Adjustment is effected using a screwdriver and the three adjusters **A**, **B** and **C** in conjunction with each other; with the lamp on, blackout and dimmer fully open, and no filters inserted in the beam. If the lamp is not correctly aligned, a hot-spot will be noticeable. This is a function of the lamp's positioning. Use the two adjusters (**B** and **C**) to bring the hot-spot to the centre of the beam. Use the third adjuster (**A**) to flatten the beam to maximum uniformity.

vertical adjustment

Adjuster (**C**) acts on a lever and spring assembly to position the lamp via a vertical movement within the reflector; rotate it until correct positioning is achieved.

horizontal adjustment

Adjuster (**B**) acts on a lever and spring assembly to position the lamp via a horizontal movement within the reflector; rotate it until correct positioning is achieved.

axial adjustment

Adjuster (**A**) moves the entire lamp axially within the unit; rotate it until correct positioning is achieved; resulting in an even, flat beam.

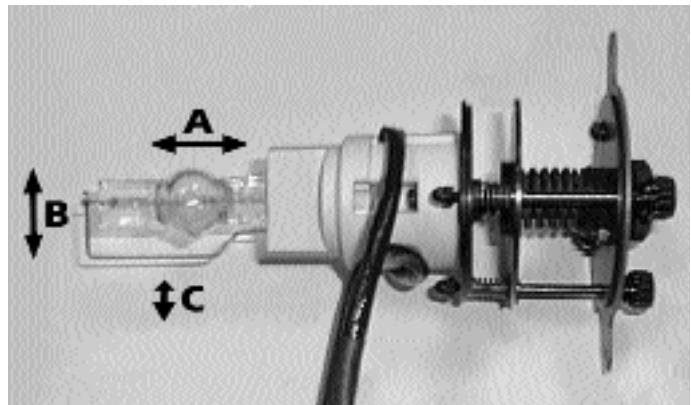

11. Maintenance

Whilst every possible precaution has been taken to ensure the trouble-free operation of your **Pilota 1200**, the following periodic maintenance is highly recommended.

Attention

Disconnect mains power prior to removing the projector housing.

Opening the lamp housing

It is possible to open the rear of the followspot in the area which houses the lamp assembly using a Phillips head screwdriver and undoing the screw at the rear of the housing. When this has been done, lift the housing cover off.

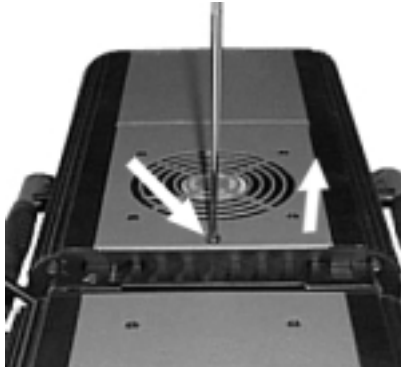

After this simple operation, you will have direct access to the lamp assembly to perform any necessary maintenance.

Opening the optics housing

To access the optics section of the **Pilota 1200** in order to perform normal maintenance routines, simply slide back the doors at the bottom of the followspot housing, as shown in the diagram.

When this is done, the user will have complete access to the optic group within the followspot.

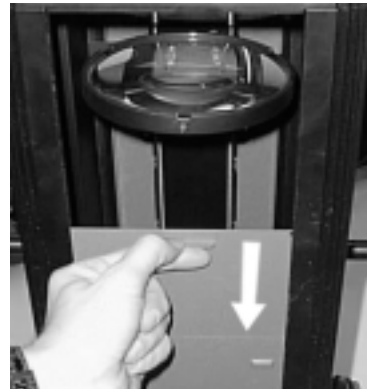

Fuse replacement

Locate the fuse, which protects the lamp and electronics, in the ballast at the base of the followspot yoke. Using a multimeter, test the condition of the fuse, replacing it with one of equivalent type if necessary.

periodic cleaning lenses and reflectors

Even a fine layer of dust can reduce the luminous output substantially. Regularly clean all lenses and the reflector using a soft cotton cloth, dampened with a specialist lens cleaning solution.

fans and air passages

The fans and air passages must be cleaned approximately every 6 weeks; the period for this periodic cleaning will depend, of course, upon the conditions in which the projector is operating. Suitable instruments for performing this type of maintenance are a brush and a common vacuum cleaner or an air compressor.

periodic maintenance lamp

The lamp should be replaced if there is any observable damage or deformation due to heat. This will avoid the danger of the lamp exploding.

mechanicals

Periodically check all mechanical devices for wear and tear, replacing them if necessary. Periodically check the lubrication of all components, particularly the parts subject to high temperatures. If necessary, lubricate with suitable lubricant, available from your coemar distributor.

electrical components

Check all electrical components for correct earthing and proper attachment of all connectors, refastening if necessary.

12. Spare Parts

All the components of the **Pilota 1200** are available as replacement spares from your authorised **coemar** sales agent. Accurate description of the fixture, model number, and type will assist us in providing for your requirements in an efficient and effective manner.